

6.1 Inverter fault and alarm indications

- When the inverter detects a fault, depending on the nature of the fault, the operation panel displays an error message or warning, or a protective function activates to trip the inverter.
- When any fault occurs, take an appropriate corrective action, then reset the inverter, and resume the operation.
Restarting the operation without a reset may break or damage the inverter.
- When a protective function activates, note the following points.

Item	Description
Fault output signal	Opening the magnetic contactor (MC) provided on the input side of the inverter at a fault occurrence shuts off the control power to the inverter, therefore, the fault output will not be retained.
Fault or alarm indication	When a protective function activates, the operation panel displays a fault indication.
Operation restart method	While a protective function is activated, the inverter output is kept shutoff. Reset the inverter to restart the operation.

- Inverter fault or alarm indications are categorized as below.

Displayed item	Description
Error message	A message regarding an operational fault and setting fault by the operation panel (FR-DU08) and parameter unit (FR-PU07). The inverter does not trip.
Warning	The inverter does not trip even when a warning. However, failure to take appropriate measures will lead to a fault.
Alarm	The inverter does not trip. An Alarm (LF) signal can also be output with a parameter setting.
Fault	A protective function activates to trip the inverter and output a Fault (ALM) signal.

REMARKS

- The past eight faults can be displayed on the operation panel. (Faults history) (For the operation, refer to [page 619](#).)

6.2 Reset method for the protective functions

Reset the inverter by performing any of the following operations. Note that the accumulated heat value of the electronic thermal relay function and the number of retries are cleared (erased) by resetting the inverter.

The inverter recovers about 1 s after the reset is released.

- On the operation panel, press  to reset the inverter.
(This may only be performed when a fault occurs. (Refer to [page 629](#) of the Instruction Manual for faults.))

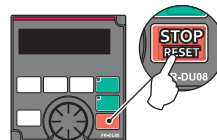

- Switch the power OFF once, then switch it ON again.

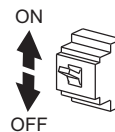

- Turn ON the reset signal (RES) for 0.1 s or more. (If the RES signal is kept ON, "Err" appears (flickers) to indicate that the inverter is in a reset status.)

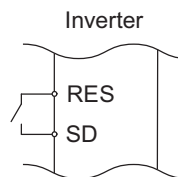

REMARKS

- OFF status of the start signal must be confirmed before resetting the inverter fault. Resetting an inverter fault with the start signal ON restarts the motor suddenly.

6.3 Check and clear of the faults history

The operation panel stores the fault indications which appears when a protective function is activated to display the fault record for the past eight faults. (Faults history)

(1) Check for the faults history

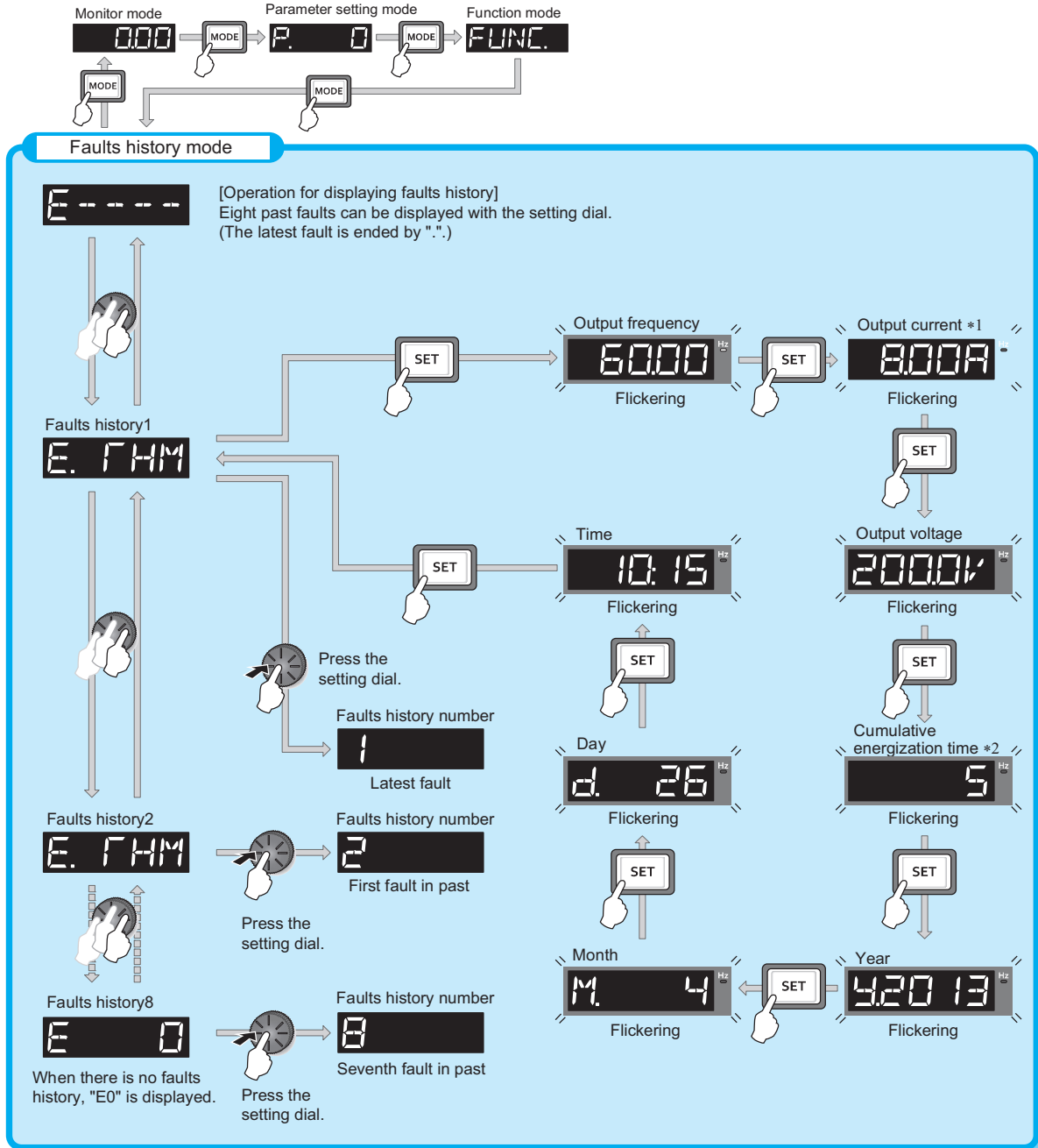









- *1 When an overcurrent trip occurs by an instantaneous overcurrent, the monitored current value saved in the faults history may be lower than the actual current that has flowed.
- *2 The cumulative energization time and actual operation time are accumulated from 0 to 65535 hours, then cleared, and accumulated again from 0.

Check and clear of the faults history

(2) Faults history clearing procedure

POINT

- Set **Err.CL Fault history clear** = "1" to clear the faults history.

Operation	
1.	Screen at power-ON The monitor display appears.
2.	Parameter setting mode Press  to choose the parameter setting mode. (The parameter number read previously appears.)
3.	Selecting the parameter number Turn  until Err.CL (faults history clear) appears. Press  to read the present set value. "0" (initial value) appears.
4.	Faults history clear Turn  to change the set value to "1". Press  to start clear. "1" and "Err.CL" flicker alternately after parameters are cleared. <ul style="list-style-type: none">• Turn  to read another parameter.• Press  to show the setting again.• Press  twice to show the next parameter.

6.4 Faults history and the list of fault displays

If the displayed message does not correspond to any of the following or if you have any other problem, please contact your sales representative.

(1) Error message

- A message regarding operational fault and setting fault by the operation panel (FR-DU08) and parameter unit (FR-PU07) is displayed. The inverter does not trip.

Operation panel indication	Name	Refer to
E-----	Faults history	619
HOLD	Operation panel lock	623
LOCd	Password locked	623
Er 1 to Er 4 Er 8	Parameter write error	623
rE 1 to rE 4 rEE to rEB	Copy operation error	624
Err.	Error	625

(2) Warning

- The inverter does not trip even when a warning is displayed. However, failure to take appropriate measures will lead to a fault.

Operation panel indication	Name	Refer to page
OL	Stall prevention (overcurrent)	626
oL	Stall prevention (overvoltage)	626
Rb	Regenerative brake pre-alarm	627
FH	Electronic thermal relay function pre-alarm	627
PS	PU stop	627
SL	Speed limit indication	627
CP	Parameter copy	627
SA	Safety stop	628
Mf 1 to Mf 3	Maintenance signal output	628
UF	USB host error	628
HP 1	Home position return setting error	628
HP 2	Home position return uncompleted	628
HP 3	Home position return parameter setting error	628
EV	24 V external power supply operation	628

(3) Alarm

- The inverter does not trip. An Alarm (LF) signal can also be output with a parameter setting.

Operation panel indication	Name	Refer to page
FN	Fan alarm	629
FN2	Internal-circulation fan alarm	629

(4) Fault

- A protective function trips the inverter and outputs a Fault (ALM) signal.
- The data code is used for checking the fault detail via communication or with **Pr.997 Fault initiation**.

Operation panel indication	Name	Data code	Refer to page
E. OC 1	Overcurrent trip during acceleration	16 (H10)	629
E. OC 2	Overcurrent trip during constant speed	17 (H11)	630
E. OC 3	Overcurrent trip during deceleration or stop	18 (H12)	630
E. OV 1	Regenerative overvoltage trip during acceleration	32 (H20)	631
E. OV 2	Regenerative overvoltage trip during constant speed	33 (H21)	631
E. OV 3	Regenerative overvoltage trip during deceleration or stop	34 (H22)	631
E. FHF	Inverter overload trip (electronic thermal relay function)	48 (H30)	632
E. FHM	Motor overload trip (electronic thermal relay function)	49 (H31)	632
E. FIN	Heatsink overheat	64 (H40)	632
E. IPF	Instantaneous power failure	80 (H50)	633
E. UVF	Undervoltage	81 (H51)	633
E. ILF	Input phase loss	82 (H52)	633
E. OLF	Stall prevention stop	96 (H60)	634
E. SDF	Loss of synchronism detection	97 (H61)	634
E. bE	Brake transistor alarm detection	112 (H70)	634
E. GF	Output side earth (ground) fault overcurrent	128 (H80)	635
E. LF	Output phase loss	129 (H81)	635

Faults history and the list of fault displays



Operation panel indication	Name	Data code	Refer to page
E. OHR	External thermal relay operation	144 (H90)	635
E. PTC	PTC thermistor operation	145 (H91)	635
E. OPR	Option fault	160 (HA0)	636
E. OP1	Communication option fault	161 (HA1)	636
E. 16	User definition error by the PLC function	164 (HA4)	636
E. 17		165 (HA5)	
E. 18		166 (HA6)	
E. 19		167 (HA7)	
E. 20		168 (HA8)	
E. PE	Parameter storage device fault	176 (HB0)	636
E. PUE	PU disconnection	177 (HB1)	637
E. REF	Retry count excess	178 (HB2)	637
E. PE2	Parameter storage device fault	179 (HB3)	637
E. CPU	CPU fault	192 (HC0)	637
E. 5		245 (HF5)	
E. 6		246 (HF6)	
E. 7		247 (HF7)	
E. CFE	Operation panel power supply short circuit RS-485 terminals power supply short circuit	193 (HC1)	637
E. P24	24 VDC power fault	194 (HC2)	638
E. CD0	Abnormal output current detection	196 (HC4)	638
E. IOH	Inrush current limit circuit fault	197 (HC5)	638
E. SER	Communication fault (inverter)	198 (HC6)	638
E. AIE	Analog input fault	199 (HC7)	638
E. USB	USB communication fault	200 (HC8)	639
E. SAF	Safety circuit fault	201 (HC9)	639
E. P6F	Internal circuit fault	202 (HCA)	639
E. 13		253 (HFD)	639
E. OS	Overspeed occurrence	208 (HD0)	639
E. OSd	Speed deviation excess detection	209 (HD1)	640

Operation panel indication	Name	Data code	Refer to page
E. ECF	Signal loss detection	210 (HD2)	640
E. Od	Excessive position fault	211 (HD3)	640
E. Mb1	Brake sequence fault	213 (HD5)	641
E. Mb2		214 (HD6)	
E. Mb3		215 (HD7)	
E. Mb4		216 (HD8)	
E. Mb5		217 (HD9)	
E. Mb6		218 (HDA)	
E. Mb7		219 (HDB)	
E. EP	Encoder phase fault	220 (HDC)	641
E. IAH	Abnormal internal temperature	225 (HE1)	641
E. LCI	4 mA input fault	228 (HE4)	641
E. PCH	Pre-charge fault	229 (HE5)	641
E. PID	PID signal fault	230 (HE6)	642
E. 1	Option fault	241 (HF1)	642
E. 2		242 (HF2)	
E. 3		243 (HF3)	
E. 11	Opposite rotation deceleration fault	251 (HFB)	642

6.5 Causes and corrective actions

(1) Error message

A message regarding operational troubles is displayed. Output is not shut off.

Operation panel indication	HOLD	HOLD
Name	Operation panel lock	
Description	Operation lock is set. Operation other than  is invalid. (Refer to page 256.)	
Check point		
Corrective action	Press  for 2 s to release the lock.	

Operation panel indication	LOCD	LOCD
Name	Password locked	
Description	Password function is active. Display and setting of parameters are restricted.	
Check point		
Corrective action	Enter the password in Pr.297 Password lock/unlock to unlock the password function before operating.(Refer to page 264.)	

Operation panel indication	Er1	Er1
Name	Parameter write error	
Description	<ul style="list-style-type: none"> Parameter setting was attempted while Pr.77 Parameter write selection is set to disable parameter write. Overlapping range has been set for the frequency jump. Overlapping range has been set for the adjustable 5 points V/F. The PU and inverter cannot make normal communication. IPM parameter initialization was attempted while Pr.72 = "25". 	
Check point	<ul style="list-style-type: none"> Check the Pr.77 Parameter write selection setting. (Refer to page 260.) Check the settings of Pr.31 to Pr.36 (frequency jump). (Refer to page 335.) Check the settings of Pr.100 to Pr.109 (adjustable 5 points V/F). (Refer to page 583.) Check the connection of PU and the inverter. Check the Pr.72 PWM frequency selection setting. A sine wave filter cannot be used under PM sensorless vector control. 	

Operation panel indication	Er2	Er2
Name	Write error during operation	
Description	Parameter write was attempted while Pr.77 = "0".	
Check point	<ul style="list-style-type: none"> Check that the inverter is stopped. 	
Corrective action	<ul style="list-style-type: none"> After stopping the operation, make parameter setting. When setting Pr.77 = "2", parameter write is enabled during operation. (Refer to page 260.) 	

Operation panel indication	Er3	Er3
Name	Calibration error	
Description	Analog input bias and gain calibration values have been set too close.	
Check point	Check the settings of calibration parameters C3, C4, C6 and C7 (calibration functions). (Refer to page 400.)	

Operation panel indication	Er4	Er4
Name	Mode designation error	
Description	<ul style="list-style-type: none"> Parameter setting was attempted in the External or NET operation mode while Pr.77 = "1". Parameter write was attempted when the command source is not at the operation panel (FR-DU08). 	
Check point	<ul style="list-style-type: none"> Check that operation mode is PU operation mode. Check that the Pr.551 setting is correct. 	
Corrective action	<ul style="list-style-type: none"> After setting the operation mode to the "PU operation mode", make parameter setting. (Refer to page 299.) When Pr.77 = "2", parameter write is enabled regardless of the operation mode. (Refer to page 260.) Set Pr.551 = "2". (Refer to page 308.) 	

Causes and corrective actions

Operation panel indication	Er8	Er8
Name	USB memory device operation error	
Description	<ul style="list-style-type: none"> • An operation command was given during the USB memory device operation. • A copy operation (writing) was performed while the PLC function was in the RUN state. • A copy operation was attempted for a password locked project. 	
Check point	<ul style="list-style-type: none"> • Check if the USB memory device is operating. • Check if the PLC function is in the RUN state. • Check if the project data is locked with a password. 	
Corrective action	<ul style="list-style-type: none"> • Perform the operation after the USB memory device operation is completed. • Stop the PLC function. (Refer to page 529 and the FR-A800 PLC function programming manual.) • Unlock the password of the project data using FR Configurator2. (Refer to the Instruction Manuals of FR Configurator2 and GX Works2.) 	

Operation panel indication	rE1	rE1
Name	Parameter read error	
Description	<ul style="list-style-type: none"> • A failure has occurred at the operation panel side EEPROM while reading the copied parameters. • A failure has occurred in the USB memory device while copying the parameters or reading the PLC function project data. 	
Check point	—	
Corrective action	<ul style="list-style-type: none"> • Perform parameter copy again. (Refer to page 609, page 612.) • Perform PLC function project data copy again. (Refer to page 529) • The USB memory device may be faulty. Replace the USB memory device. • The operation panel (FR-DU08) may be faulty. Please contact your sales representative. 	

Operation panel indication	rE2	rE2
Name	Parameter write error	
Description	<ul style="list-style-type: none"> • Parameter copy from the operation panel to the inverter was attempted during operation. • A failure has occurred at the operation panel side EEPROM while writing the copied parameters. • A failure has occurred in the USB memory device while writing the copied parameters or PLC function project data. 	
Check point	<ul style="list-style-type: none"> • Check that the inverter is stopped. 	
Corrective action	<ul style="list-style-type: none"> • After stopping the operation, perform parameter copy again. (Refer to page 609.) • The operation panel (FR-DU08) may be faulty. Please contact your sales representative. • Perform parameter copy or PLC project data copy again. (Refer to page 529 and page 612) • The USB memory device may be faulty. Replace the USB memory device. 	

Operation panel indication	rE3	rE3
Name	Parameter verification error	
Description	<ul style="list-style-type: none"> • The data in the inverter are different from the data in the operation panel. • A failure has occurred at the operation panel side EEPROM during parameter verification. • A failure has occurred in the USB memory device during parameter verification. • The data in the inverter are different from the data in the USB memory device or the personal computer (FR Configurator2) 	
Check point	<ul style="list-style-type: none"> • Check the parameter setting of the source inverter against the setting of the destination inverter. 	
Corrective action	<ul style="list-style-type: none"> • Continue the verification by pressing <input type="button" value="SET"/>. • Perform parameter verification again. (Refer to page 611.) • The operation panel (FR-DU08) may be faulty. Please contact your sales representative. • The USB memory device may be faulty. Replace the USB memory device. • Verify the PLC function project data again. (Refer to page 529.) 	

Operation panel indication	rE4	rE4
Name	Model error	
Description	<ul style="list-style-type: none"> A different model was used when parameter copy from the operation panel or parameter verification was performed. The data in the operation panel were not correct when parameter copy from the operation panel or parameter verification was performed. 	
Check point	<ul style="list-style-type: none"> Check that the parameter copy or verification source inverter is of the same model. Check that parameter copy to the operation panel was not interrupted by switching OFF the power or by disconnecting the operation panel. 	
Corrective action	<ul style="list-style-type: none"> Perform parameter copy and parameter verification between inverters of the same model (FR-A800 series). Perform parameter copy to the operation panel from the inverter again. 	

Operation panel indication	rE6	rE6
Name	File error	
Description	<ul style="list-style-type: none"> The parameter copy file in the USB memory device cannot be recognized. An error has occurred in the file system during transfer of the PLC function data or writing to RAM. 	
Check point	—	
Corrective action	<ul style="list-style-type: none"> Perform parameter copy again.(Refer to page 612.) Copy the PLC function project data again.(Refer to page 529.) 	

Operation panel indication	rE7	rE7
Name	File quantity error	
Description	<ul style="list-style-type: none"> A parameter copy was attempted to the USB memory device in which the copy files from 001 to 099 had already been saved. 	
Check point	<ul style="list-style-type: none"> Check if the number of copy files in the USB memory device has reached 99. 	
Corrective action	<ul style="list-style-type: none"> Delete the copy file in the USB memory device and perform parameter copy again.(Refer to page 612.) 	

Operation panel indication	rE8	rE8
Name	No PLC function project file	
Description	The specified PLC function project file does not exist in the USB memory device.	
Check point	<ul style="list-style-type: none"> Check that the file exists in the USB memory device. Check that the folder name and the file name in the USB memory device is correct. 	
Corrective action	The data in the USB memory device may be damaged.	

Operation panel indication	Err.	Err.
Description	<ul style="list-style-type: none"> The RES signal is turned ON. The operation panel and inverter cannot make normal communication (contact faults of the connector). This error may occur when the voltage at the input side of the inverter drops. When using a separate power source for the control circuit power (R1/L11, S1/L21) from the main circuit power (R/L1, S/L2, T/L3), this error may appear at turning ON of the main circuit. It is not a fault. 	
Corrective action	<ul style="list-style-type: none"> Turn OFF the RES signal. Check the connection between the operation panel and the inverter. Check the voltage on the input side of the inverter. 	

Causes and corrective actions

(2) Warning





Output is not shut off when a protective function activates.

Operation panel indication	OL		FR-PU07	OL
Name	Stall prevention (overcurrent)			
Description	<ul style="list-style-type: none"> When the output current of the inverter increases, the stall prevention (overcurrent) function activates. The following section explains about the stall prevention (overcurrent) function. 			
	During acceleration	When the output current (output torque under Real sensorless vector control or vector control) of the inverter exceeds the stall prevention level (Pr.22 Stall prevention operation level , etc.), this function stops the increase in frequency until the overload current decreases to prevent the inverter from resulting in overcurrent trip. When the overload current has reduced below stall prevention operation level, this function increases the frequency again.		
	During constant-speed operation	When the output current (output torque under Real sensorless vector control or vector control) of the inverter exceeds the stall prevention level (Pr.22 Stall prevention operation level , etc.), this function reduces frequency until the overload current decreases to prevent the inverter from resulting in overcurrent trip. When the overload current has reduced below stall prevention operation level, this function increases the frequency up to the set value.		
	During deceleration	When the output current (output torque under Real sensorless vector control or vector control) of the inverter exceeds the stall prevention level (Pr.22 Stall prevention operation level , etc.), this function stops the decrease in frequency until the overload current decreases to prevent the inverter from resulting in overcurrent trip. When the overload current has decreased below stall prevention operation level, this function decreases the frequency again.		
Check point	<ul style="list-style-type: none"> Check that the Pr.0 Torque boost setting is not too large. The Pr.7 Acceleration time and Pr.8 Deceleration time settings may be too short. Check that the load is not too heavy. Check for any failures in peripheral devices. Check that the Pr.13 Starting frequency is not too large. Check that Pr.22 Stall prevention operation level is appropriate. 			
Corrective action	<ul style="list-style-type: none"> Gradually increase or decrease the Pr.0 setting by 1% at a time and check the motor status. (Refer to page 577.) Set a larger value in Pr.7 Acceleration time and Pr.8 Deceleration time. (Refer to page 278.) Reduce the load. Try Advanced magnetic flux vector control, Real sensorless vector control, or vector control. Change the Pr.14 Load pattern selection setting. The stall prevention operation current can be set in Pr.22 Stall prevention operation level. (Initial value is 150%.) The acceleration/deceleration time may change. Increase the stall prevention operation level with Pr.22 Stall prevention operation level, or disable stall prevention with Pr.156 Stall prevention operation selection. (Use Pr.156 to set either operation continued or not at OL operation.) 			

Operation panel indication	oL		FR-PU07	oL
Name	Stall prevention (overvoltage)			
Description	<ul style="list-style-type: none"> When the output voltage of the inverter increases, the stall prevention (overvoltage) function activates. The regeneration avoidance function activates due to excessive regenerative power of the motor. (Refer to page 599.) The following section explains the stall prevention (overvoltage) function. 			
	During deceleration	If the regenerative power of the motor becomes excessive to exceed the regenerative power consumption capability, this function stops decreasing the frequency to prevent overvoltage trip. As soon as the regenerative power has reduced, deceleration resumes.		
Check point	<ul style="list-style-type: none"> Check for sudden speed reduction. Check if the regeneration avoidance function (Pr.882 to Pr.886) is being used. (Refer to page 599.) 			
Corrective action	The deceleration time may change. Increase the deceleration time using Pr.8 Deceleration time .			

Operation panel indication	RB		FR-PU07	RB
Name	Regenerative brake pre-alarm			
Description	Appears if the regenerative brake duty reaches or exceeds 85% of the Pr.70 Special regenerative brake duty value. If the regenerative brake duty reaches 100%, a regenerative overvoltage (E. OV[]) occurs.			
Check point	<ul style="list-style-type: none"> • Check if the brake resistor duty is not too high. • Check that the Pr.30 Regenerative function selection and Pr.70 settings are correct. 			
Corrective action	<ul style="list-style-type: none"> • Set the deceleration time longer. • Check the Pr.30 and Pr.70 settings. (Refer to page 593.) 			

Operation panel indication	TH		FR-PU07	TH
Name	Electronic thermal relay function pre-alarm			
Description	Appears if the cumulative value of the electronic thermal O/L relay reaches or exceeds 85% of the preset level of Pr.9 Electronic thermal O/L relay . If the value reaches 100% of Pr.9 setting, motor overload trip (E.THM) occurs.			
Check point	<ul style="list-style-type: none"> • Check for large load or sudden acceleration. • Check that the Pr.9 setting is appropriate. (Refer to page 322.) 			
Corrective action	<ul style="list-style-type: none"> • Reduce the load and frequency of operation. • Set an appropriate value in Pr.9. (Refer to page 322.) 			

Operation panel indication	PS		FR-PU07	PS
Name	PU stop			
Description	<ul style="list-style-type: none"> • The motor is stopped using  under the mode other than the PU operation mode. (To enable  under the mode other than the PU operation mode, set Pr.75 Reset selection/disconnected PU detection/PU stop selection. Refer to page 252 for details.) • The motor is stopped by the emergency stop function. 			
Check point	<ul style="list-style-type: none"> • Check for a stop made by pressing  of the operation panel. • Check for whether the X92 signal is OFF. 			
Corrective action	<ul style="list-style-type: none"> • Turn the start signal OFF and release with . • Turn ON the X92 signal and OFF the start signal for release. 			

Operation panel indication	SL		FR-PU07	SL
Name	Speed limit indication			
Description	Output if the speed limit level is exceeded during torque control.			
Check point	<ul style="list-style-type: none"> • Check that the torque command is not larger than required. • Check if the speed limit level is set too low. 			
Corrective action	<ul style="list-style-type: none"> • Decrease the torque command value. • Increase the speed limit level. 			

Operation panel indication	CP		FR-PU07	CP
Name	Parameter copy			
Description	Appears when parameter copy is performed between inverters FR-A820-03160(55K) or lower, FR-A840-01800(55K) or lower, FR-A820-03800(75K) or higher and FR-A840-02160(75K) or higher			
Check point	Resetting of Pr.9, Pr.30, Pr.51, Pr.56, Pr.57, Pr.61, Pr.70, Pr.72, Pr.80, Pr.82, Pr.90 to Pr.94, Pr.453, Pr.455, Pr.458 to Pr.462, Pr.557, Pr.859, Pr.860 and Pr.893 is necessary.			
Corrective action	Set the initial value in Pr.989 Parameter copy alarm release .			

Causes and corrective actions

Operation panel indication	SA	SA	FR-PU07	—
Name	Safety stop			
Description	Appears when safety stop function is activated (during output shutoff). (Refer to page 57.)			
Check point	<ul style="list-style-type: none"> • Check if an emergency stop device is activated. • Check if the shorting wire between S1 and PC or between S2 and PC is disconnected when not using the safety stop function. 			
Corrective action	<ul style="list-style-type: none"> • An emergency stop device is active when using the safety stop function. Identify the cause of emergency stop, ensure the safety and restart the system. • When not using the safety stop function, short across terminals S1 and PC and across S2 and PC with shorting wire for the inverter to run. • If SA is indicated when wires across S1 and SIC and across S2 and SIC are both conducted while using the safety stop function (drive enabled), internal failure might be the cause. Check the wiring of terminals S1, S2 and SIC and contact your sales representative if the wiring has no fault. 			

Operation panel indication	MT1 to MT3	MT 1 to MT 3	FR-PU07	MT*1
Name	Maintenance signal output 1 to 3			
Description	<p>Appears when the inverter's cumulative energization time reaches or exceeds the parameter set value. Set the time until the MT is displayed using Pr.504 Maintenance timer 1 warning output set time (MT1), Pr.687 Maintenance timer 2 warning output set time (MT2), and Pr.689 Maintenance timer 3 warning output set time (MT3).</p> <p>MT does not appear when the settings of Pr.504, Pr.687, and Pr.689 are initial values (9999).</p>			
Check point	The set time of maintenance timer has been exceeded. (Refer to page 274.)			
Corrective action	Take appropriate countermeasures according to the purpose of the maintenance timer setting. Setting "0" in Pr.503 Maintenance timer 1 , Pr.686 Maintenance timer 2 , and Pr.688 Maintenance timer 3 clears the indication.			

*1 MT appears for all of MT1, MT2 and MT3.

Operation panel indication	UF	UF	FR-PU07	—
Name	USB host error			
Description	Appears when an excessive current flows into the USB A connector.			
Check point	Check if a USB device other than a USB memory device is connected to the USB A connector.			
Corrective action	<ul style="list-style-type: none"> • If a device other than a USB memory device is connected to the USB A connector, remove the device. • Setting Pr.1049 USB host reset = "1" or inverter reset clears the UF indication. 			

Operation panel indication	HP1 to HP3	HP 1 to HP 3	FR-PU07	—
Name	Home position return error			
Description	Appears when an error occurs during the home position return operation under position control. For the details, refer to page 237.			
Check point	Identify the cause of the error occurrence.			
Corrective action	Check the parameter setting, and check that the input signal is correct.			

Operation panel indication	EV	EV	FR-PU07	—
Name	24 V external power supply operation			
Description	Flickers when the main circuit power supply is off and the 24 V external power supply is being input.			
Check point	<ul style="list-style-type: none"> • Power is supplied from a 24 V external power supply. 			
Corrective action	<ul style="list-style-type: none"> • Turning ON the power supply (main circuit) of the inverter clears the indication. • If the indication is still displayed after turning ON of the power supply (main circuit) of the inverter, the power supply voltage may be low, or the jumper between the terminals P/+ and P1 may be disconnected. 			

(3) Alarm

Output is not shut off when a protective function activates. An alarm can also be output with a parameter setting. (Set "98" in **Pr.190 to Pr.196 (output terminal function selection)**. (Refer to [page 370](#).)

Operation panel indication	FN	FN	FR-PU07	FN
Name	Fan alarm			
Description	For the inverter that contains a cooling fan, FN appears on the operation panel when the cooling fan stops due to a fault, low rotation speed or different operation from the setting of Pr.244 Cooling fan operation selection .			
Check point	Check the cooling fan for a failure.			
Corrective action	The fan may be faulty. Please contact your sales representative.			

Operation panel indication	FN2	FN2	FR-PU07	FN2
Name	Internal-circulation fan alarm (IP55 compatible models only)			
Description	FN2 appears on the operation panel when the internal air circulation fan stops due to a fault or low rotation speed.			
Check point	Check the internal air circulation fan for a failure.			
Corrective action	The fan may be faulty. Please contact your sales representative.			

(4) Fault

When a protective function activates, the inverter trips and a fault signal is output.

Operation panel indication	E.OC1	E. OC 1	FR-PU07	OC During Acc
Name	Overcurrent trip during acceleration			
Description	When the inverter output current reaches or exceeds approximately 235%*1 of the rated current during acceleration, the protection circuit is activated and the inverter trips.			
Check point	<ul style="list-style-type: none"> • Check for sudden speed acceleration. • Check if the downward acceleration time is too long in a lift application. • Check for output short-circuit. • Check that the Pr.3 Base frequency setting is not 60 Hz when the motor rated frequency is 50 Hz. • Check if the stall prevention operation level is set too high. Check if the fast-response current limit operation is disabled. • Check that the regenerative driving is not performed frequently. (Check if the output voltage becomes larger than the V/F reference voltage at regenerative driving and overcurrent occurs due to increase in the motor current.) • Check that the power supply for RS-485 terminal is not shorted (under vector control). • Check that the encoder wiring and the specifications (encoder power supply, resolution, differential/complementary) are correct. Check also that the motor wiring (U, V, W) is correct (under vector control). • Check that the rotation direction is not switched from forward to reverse rotation (or from reverse to forward) during torque control under Real sensorless vector control. • Check that the inverter capacity matches with the motor capacity. (PM sensorless vector control) • Check if a start command is given to the inverter while the motor is coasting. (PM sensorless vector control) 			
Corrective action	<ul style="list-style-type: none"> • Set the acceleration time longer. (Shorten the downward acceleration time of the lift.) • If "E.OC1" always appears at start, disconnect the motor once and restart the inverter. If "E.OC1" still appears, contact your sales representative. • Check the wiring to make sure that output short circuit does not occur. • Set 50 Hz in Pr.3 Base frequency. (Refer to page 578.) • Lower the stall prevention operation level. Activate the fast-response current limit operation. (Refer to page 336.) • Set the base voltage (rated voltage of the motor, etc.) in Pr.19 Base frequency voltage. (Refer to page 578.) • Check RS-485 terminal connection (under vector control). • Check the wiring and specifications of the encoder and the motor. Perform the setting according to the specifications of the encoder and the motor (under vector control). (Refer to page 62.) • Prevent the motor from switching the rotation direction from forward to reverse (or from reverse to forward) during torque control under Real sensorless vector control. • Choose inverter and motor capacities that match. (PM sensorless vector control) • Input a start command after the motor stops. Alternatively, use the automatic restart after instantaneous power failure/flying start function. (Refer to page 517.) (IPM sensorless vector control) 			

*1 Differs according to ratings. The rating can be changed using **Pr.570 Multiple rating setting**. (Refer to [page 258](#).)
 148% for SLD rating, 170% for LD rating, 235% for ND rating (initial setting), and 280% for HD rating

Causes and corrective actions

Operation panel indication	E.OC2	E. OC2	FR-PU07	Stedy Spd OC
Name	Overcurrent trip during constant speed			
Description	When the inverter output current reaches or exceeds approximately 235%*2 of the rated current during constant-speed operation, the protection circuit is activated and the inverter trips.			
Check point	<ul style="list-style-type: none"> • Check for sudden load change. • Check for output short-circuit. • Check if the stall prevention operation level is set too high. Check if the fast-response current limit operation is disabled. • Check that the power supply for RS-485 terminal is not shorted (under vector control). • Check that the rotation direction is not switched from forward to reverse rotation (or from reverse to forward) during torque control under Real sensorless vector control. • Check that the inverter capacity matches with the motor capacity. (PM sensorless vector control) • Check if a start command is given to the inverter while the motor is coasting. (PM sensorless vector control) 			
Corrective action	<ul style="list-style-type: none"> • Keep the load stable. • Check the wiring to make sure that output short circuit does not occur. • Lower the stall prevention operation level. Activate the fast-response current limit operation. (Refer to page 336.) • Check RS-485 terminal connection (under vector control). • Prevent the motor from switching the rotation direction from forward to reverse (or from reverse to forward) during torque control under Real sensorless vector control. • Choose inverter and motor capacities that match. (PM sensorless vector control) • Input a start command after the motor stops. Alternatively, use the automatic restart after instantaneous power failure/flying start function. (Refer to page 517.) (PM sensorless vector control) 			

*2 Differs according to ratings. The rating can be changed using **Pr.570 Multiple rating setting**. (Refer to [page 258](#).)
148% for SLD rating, 170% for LD rating, 235% for ND rating (initial setting), and 280% for HD rating

Operation panel indication	E.OC3	E. OC3	FR-PU07	OC During Dec
Name	Overcurrent trip during deceleration or stop			
Description	When the inverter output current reaches or exceeds approximately 235%*3 of the rated current during deceleration (other than acceleration or constant speed), the protection circuit is activated and the inverter trips.			
Check point	<ul style="list-style-type: none"> • Check for sudden speed reduction. • Check for output short-circuit. • Check for too fast operation of the motor's mechanical brake. • Check if the stall prevention operation level is set too high. Check if the fast-response current limit operation is disabled. • Check that the power supply for RS-485 terminal is not shorted (under vector control). • Check that the rotation direction is not switched from forward to reverse rotation (or from reverse to forward) during torque control under Real sensorless vector control. • Check that the inverter capacity matches with the motor capacity. (PM sensorless vector control) • Check if a start command is given to the inverter while the motor is coasting. (PM sensorless vector control) 			
Corrective action	<ul style="list-style-type: none"> • Set the deceleration time longer. • Check the wiring to make sure that output short circuit does not occur. • Check the mechanical brake operation. • Lower the stall prevention operation level. Activate the fast-response current limit operation. (Refer to page 336.) • Check RS-485 terminal connection (under vector control). • Prevent the motor from switching the rotation direction from forward to reverse (or from reverse to forward) during torque control under Real sensorless vector control. • Choose inverter and motor capacities that match. (PM sensorless vector control) • Input a start command after the motor stops. Alternatively, use the automatic restart after instantaneous power failure/flying start function. (Refer to page 517.) (PM sensorless vector control) 			

*3 Differs according to ratings. The rating can be changed using **Pr.570 Multiple rating setting**. (Refer to [page 258](#).)
148% for SLD rating, 170% for LD rating, 235% for ND rating (initial setting), and 280% for HD rating

Operation panel indication	E.OV1	E. OV1	FR-PU07	OV During Acc
Name	Regenerative overvoltage trip during acceleration			
Description	If regenerative power causes the inverter's internal main circuit DC voltage to reach or exceed the specified value, the protection circuit is activated to stop the inverter output. The circuit may also be activated by a surge voltage produced in the power supply system.			
Check point	<ul style="list-style-type: none"> • Check for too slow acceleration. (e.g. during downward acceleration in vertical lift load) • Check that the Pr.22 Stall prevention operation level is not set to the no load current or lower. • Check if the stall prevention operation is frequently activated in an application with a large load inertia. 			
Corrective action	<ul style="list-style-type: none"> • Set the acceleration time shorter. • Use the regeneration avoidance function (Pr.882 to Pr.886). (Refer to page 599.) • Set a value larger than the no load current in Pr.22. • Set Pr.154 Voltage reduction selection during stall prevention operation = "10, 11". (Refer to page 336.) 			

Operation panel indication	E.OV2	E. OV2	FR-PU07	Stedy Spd OV
Name	Regenerative overvoltage trip during constant speed			
Description	If regenerative power causes the inverter's internal main circuit DC voltage to reach or exceed the specified value, the protection circuit is activated to stop the inverter output. The circuit may also be activated by a surge voltage produced in the power supply system.			
Check point	<ul style="list-style-type: none"> • Check for sudden load change. • Check that the Pr.22 Stall prevention operation level is not set to the no load current or lower. • Check if the stall prevention operation is frequently activated in an application with a large load inertia. • Check that acceleration/deceleration time is not too short. 			
Corrective action	<ul style="list-style-type: none"> • Keep the load stable. • Use the regeneration avoidance function (Pr.882 to Pr.886). (Refer to page 599.) • Use the brake unit or power regeneration common converter (FR-CV) as required. • Set a value larger than the no load current in Pr.22. • Set Pr.154 Voltage reduction selection during stall prevention operation = "10, 11". (Refer to page 336.) • Set the acceleration/deceleration time longer. (Under vector control or Advanced magnetic flux vector control, the output torque can be increased. However, sudden acceleration may cause an overshoot in speed, resulting in an occurrence of overvoltage.) 			

Operation panel indication	E.OV3	E. OV3	FR-PU07	OV During Dec
Name	Regenerative overvoltage trip during deceleration or stop			
Description	If regenerative power causes the inverter's internal main circuit DC voltage to reach or exceed the specified value, the protection circuit is activated to stop the inverter output. The circuit may also be activated by a surge voltage produced in the power supply system.			
Check point	<ul style="list-style-type: none"> • Check for sudden speed reduction. • Check if the stall prevention operation is frequently activated in an application with a large load inertia. 			
Corrective action	<ul style="list-style-type: none"> • Set the deceleration time longer. (Set the deceleration time which matches the moment of inertia of the load.) • Make the brake cycle longer. • Use the regeneration avoidance function (Pr.882 to Pr.886). (Refer to page 599.) • Use the brake unit or power regeneration common converter (FR-CV) as required. • Set Pr.154 Voltage reduction selection during stall prevention operation = "10, 11". (Refer to page 336.) 			

Causes and corrective actions

Operation panel indication	E.THT	E. FHT	FR-PU07	Inv. Overload
Name	Inverter overload trip*4			
Description	When the temperature of the output transistor element exceeds the protection level while a current flows at the rated output current level or higher without causing an overcurrent trip (E.OC[]), the inverter output is stopped.(Permissible overload capacity 150% 60 s)			
Check point	<ul style="list-style-type: none"> • Check that acceleration/deceleration time is not too short. • Check that torque boost setting is not too large (small). • Check that load pattern selection setting is appropriate for the load pattern of the using machine. • Check the motor for the use under overload. • Check that the encoder wiring and the specifications (encoder power supply, resolution, differential/complementary) are correct. Check also that the motor wiring (U, V, W) is correct (under vector control). 			
Corrective action	<ul style="list-style-type: none"> • Set the acceleration/deceleration time longer. • Adjust the torque boost setting. • Set the load pattern selection setting according to the load pattern of the using machine. • Reduce the load. • Check the wiring and specifications of the encoder and the motor. Perform the setting according to the specifications of the encoder and the motor (under vector control). (Refer to page 62.) 			

*4 Resetting the inverter initializes the internal cumulative heat value of the electronic thermal O/L relay function.

Operation panel indication	E.THM	E. FHM	FR-PU07	Motor Ovrload
Name	Motor overload trip*5			
Description	The electronic thermal O/L relay function in the inverter detects motor overheating, which is caused by overload or reduced cooling capability during low-speed operation. When the cumulative heat value reaches 85% of the Pr.9 Electronic thermal O/L relay setting, pre-alarm (TH) is output. When the accumulated value reaches the specified value, the protection circuit is activated to stop the inverter output.			
Check point	<ul style="list-style-type: none"> • Check the motor for the use under overload. • Check that the setting of Pr.71 Applied motor for motor selection is correct. (Refer to page 424.) • Check that the stall prevention operation setting is correct. 			
Corrective action	<ul style="list-style-type: none"> • Reduce the load. • For a constant-torque motor, set the constant-torque motor in Pr.71. • Set the stall prevention operation level accordingly. (Refer to page 336.) 			

*5 Resetting the inverter initializes the internal cumulative heat value of the electronic thermal O/L relay function.

Operation panel indication	E.FIN	E. FIN	FR-PU07	H/Sink O/Temp
Name	Heatsink overheat			
Description	<p>When the heatsink overheats, the temperature sensor activates, and the inverter output is stopped.</p> <p>The FIN signal can be output when the temperature becomes approximately 85% of the heatsink overheat protection operation temperature.</p> <p>For the terminal used for the FIN signal output, assign the function by setting "26 (positive logic) or 126 (negative logic)" from Pr.190 to Pr.196 (output terminal function selection). (Refer to page 370.)</p>			
Check point	<ul style="list-style-type: none"> • Check for too high surrounding air temperature. • Check for heatsink clogging. • Check that the cooling fan is not stopped. (Check that FN is not displayed on the operation panel.) 			
Corrective action	<ul style="list-style-type: none"> • Set the surrounding air temperature to within the specifications. • Clean the heatsink. • Replace the cooling fan. 			



Operation panel indication	E.IPF	E. I PF	FR-PU07	Inst. Pwr. Loss
Name	Instantaneous power failure			
Description	If a power failure occurs for longer than 15 ms*6 (this also applies to inverter input shut-off), the instantaneous power failure protective function is activated to trip the inverter in order to prevent the control circuit from malfunctioning. If a power failure persists for 100 ms or longer, the fault warning output is not provided, and the inverter restarts if the start signal is ON upon power restoration. (The inverter continues operating if an instantaneous power failure is within 15 ms*6.) In some operating status (load magnitude, acceleration/ deceleration time setting, etc.), overcurrent or other protection may be activated upon power restoration. When instantaneous power failure protection is activated, the IPF signal is output. (Refer to page 511 , page 517 .)			
Check point	Find the cause of instantaneous power failure occurrence.			
Corrective action	<ul style="list-style-type: none"> Remedy the instantaneous power failure. Prepare a backup power supply for instantaneous power failure. Set the function of automatic restart after instantaneous power failure (Pr. 57). (Refer to page 511 , page 517 .)			

*6 10 ms for IP55 compatible models

Operation panel indication	E.UVT	E. UVT	FR-PU07	Under Voltage
Name	Undervoltage			
Description	If the power supply voltage of the inverter decreases, the control circuit will not perform normal functions. In addition, the motor torque will be insufficient and/or heat generation will increase. To prevent this, if the power supply voltage decreases to about 150 VAC (300 VAC for the 400 V class) or below, this function shuts off the inverter output. When a jumper is not connected across P/+ and P1, the undervoltage protective function is activated. When undervoltage protection is activated, the IPF signal is output. (Refer to page 511 , page 517 .)			
Check point	<ul style="list-style-type: none"> Check if a high-capacity motor is driven. Check if the jumper is connected across terminals P/+ and P1. 			
Corrective action	<ul style="list-style-type: none"> Check the power supply system equipment such as the power supply. Do not remove the jumper across terminals P/+ and P1 except when connecting a DC reactor. If the problem still persists after taking the above measure, contact your sales representative. 			

Operation panel indication	E.ILF	E. I LF	FR-PU07	Input phase loss
Name	Input phase loss			
Description	When Pr.872 Input phase loss protection selection is enabled ("1") and one of the three-phase power input is lost, the inverter output is shut off. This protective function is not available when Pr.872 is set to the initial value (Pr.872 = "0").(Refer to page 331)			
Check point	Check for a break in the cable for the three-phase power supply input.			
Corrective action	<ul style="list-style-type: none"> Wire the cables properly. Repair a break portion in the cable. 			

Causes and corrective actions

Operation panel indication	E.OLT	E. OLT	FR-PU07	Still Prev STP
Name	Stall prevention stop			
Description	<p> If the output frequency has fallen to 0.5 Hz by stall prevention operation and remains for 3 s, a fault (E.OLT) appears and the inverter trips. OL appears while stall prevention is being activated.</p> <p> When speed control is performed, a fault (E.OLT) appears and the inverter trips if frequency drops to the Pr.865 Low speed detection (initial value is 1.5 Hz) setting by torque limit operation and the output torque exceeds the Pr.874 OLT level setting (initial value is 150%) setting and remains 3 s.</p>			
Check point	<ul style="list-style-type: none"> • Check the motor for the use under overload. • Check that the Pr.865 and Pr.874 values are correct. (Check the Pr.22 Stall prevention operation level setting under V/F control and Advanced magnetic flux vector control.) • Check if a motor is connected under PM sensorless vector control. 			
Corrective action	<ul style="list-style-type: none"> • Reduce the load. • Change the Pr.22, Pr.865, and Pr.874 values. (Check the Pr.22 setting under V/F control and Advanced magnetic flux vector control.) • For a test run without connecting a motor, select the PM sensorless vector control test operation. (Refer to page 162.) • Also check that the stall prevention (overcurrent) warning (OL) or the stall prevention (overvoltage) warning (oL) countermeasure is taken. 			

Operation panel indication	E.SOT	E. SOT	FR-PU07	Motor step out
Name	 Loss of synchronism detection			
Description	The inverter trips when the motor operation is not synchronized. (This function is only available under PM sensorless vector control.)			
Check point	<ul style="list-style-type: none"> • Check that the PM motor is not driven overloaded. • Check if a start command is given to the inverter while the PM motor is coasting. • Check if a motor is connected under PM sensorless vector control. • Check if a PM motor other than the MM-CF series is driven. 			
Corrective action	<ul style="list-style-type: none"> • Set the acceleration time longer. • Reduce the load. • If the inverter restarts during coasting, set Pr.57 Restart coasting time ≠ "9999", and select the automatic restart after instantaneous power failure. • Check the connection of the IPM motor. • For a test run without connecting a motor, select the PM sensorless vector control test operation. (Refer to page 162.) • Drive an IPM motor (MM-CF series) • When driving an IPM motor other than MM-CF series, offline auto tuning must be performed. (Refer to page 438.) 			

Operation panel indication	E.BE	E. bE	FR-PU07	Br.Cct.Fault
Name	Brake transistor alarm detection			
Description	<ul style="list-style-type: none"> • The inverter trips if a fault due to damage of the brake transistor and such occurs in the brake circuit. <u>In such a case, the power supply to the inverter must be shut off immediately.</u> • Appears when an internal circuit fault occurred for IP55 compatible models. 			
Check point	<ul style="list-style-type: none"> • Reduce the load inertia. • Check that the brake duty is proper. 			
Corrective action	Replace the inverter.			

Operation panel indication	E.GF	E. GF	FR-PU07	Ground Fault
Name	Output side earth (ground) fault overcurrent			
Description	The inverter trips if an earth (ground) fault overcurrent flows due to an earth (ground) fault that occurred on the inverter's output side (load side).			
Check point	Check for an earth (ground) fault in the motor and connection cable.			
Corrective action	Remedy the earth (ground) fault portion.			

Operation panel indication	E.LF	E. LF	FR-PU07	E.LF
Name	Output phase loss			
Description	The inverter trips if one of the three phases (U, V, W) on the inverter's output side (load side) is lost.			
Check point	<ul style="list-style-type: none"> • Check the wiring. (Check that the motor is normally operating.) • Check that the capacity of the motor used is not smaller than that of the inverter. • Check if a start command is given to the inverter while the motor is coasting. (PM sensorless vector control) 			
Corrective action	<ul style="list-style-type: none"> • Wire the cables properly. • Input a start command after the motor stops. Alternatively, use the automatic restart after instantaneous power failure/flying start function (page 517). (PM sensorless vector control) 			

Operation panel indication	E.OHT	E. OHT	FR-PU07	OH Fault
Name	External thermal relay operation			
Description	The inverter trips if the external thermal relay provided for motor overheat protection or the internally mounted thermal relay in the motor, etc. switches ON (contacts open). This function is available when "7" (OH signal) is set in any of Pr.178 to Pr.189 (input terminal function selection). This protective function is not available in the initial status. (OH signal is not assigned.)			
Check point	<ul style="list-style-type: none"> • Check for motor overheating. • Check that the value "7" (OH signal) is set correctly to any of Pr.178 to Pr.189 (input terminal function selection). 			
Corrective action	<ul style="list-style-type: none"> • Reduce the load and operation duty. • Even if the relay contacts are reset automatically, the inverter will not restart unless it is reset. 			

Operation panel indication	E.PTC	E. PTC	FR-PU07	PTC activated
Name	PTC thermistor operation			
Description	The inverter trips if resistance of the PTC thermistor connected between the terminal 2 and terminal 10 has reached the Pr.561 PTC thermistor protection level setting or higher. When the initial value (Pr.561 = "9999") is set, this protective function is not available.			
Check point	<ul style="list-style-type: none"> • Check the connection with the PTC thermistor. • Check the Pr.561 setting. • Check the motor for operation under overload. 			
Corrective action	Reduce the load.			

Causes and corrective actions

Operation panel indication	E.OPT	E. OPT	FR-PU07	Option Fault
Name	Option fault			
Description	<ul style="list-style-type: none"> • Appears when the AC power supply is connected to the terminal R/L1, S/L2, or T/L3 accidentally when a high power factor converter (FR-HC2) or power regeneration common converter (FR-CV) is connected (when Pr.30 Regenerative function selection = "2"). • Appears when torque command by the plug-in option is selected using Pr.804 Torque command source selection and no plug-in option is mounted. This function is available under torque control. • Appears when the switch for manufacturer setting of the plug-in option is changed. • Appears when a communication option is connected while Pr.296 Password lock level = "0 or 100". 			
Check point	<ul style="list-style-type: none"> • Check that the AC power supply is not connected to the terminal R/L1, S/L2, or T/L3 when a high power factor converter (FR-HC2) or power regeneration common converter (FR-CV) is connected (when Pr.30 = "2"). • Check that the plug-in option for torque command setting is connected. • Check for the password lock with a setting of Pr.296 = "0, 100". 			
Corrective action	<ul style="list-style-type: none"> • Check the Pr.30 setting and wiring. • The inverter may be damaged if the AC power supply is connected to the terminal R/L1, S/L2, or T/L3 when a high power factor converter is connected. Please contact your sales representative. • Check for connection of the plug-in option. Check the Pr.804 setting. • Set the switch on the plug-in option, which is for manufacturer setting, back to the initial setting. (Refer to the Instruction Manual of each option.) • To apply the password lock when installing a communication option, set Pr.296 ≠ "0, 100". (Refer to page 262.) 			

Operation panel indication	E.OP1	E. OP1	FR-PU07	Option1 Fault
Name	Communication option fault			
Description	The inverter trips if a communication line error occurs in the communication option.			
Check point	<ul style="list-style-type: none"> • Check for an incorrect option function setting and operation. • Check that the plug-in option is plugged into the connector properly. • Check for a break in the communication cable. • Check that the terminating resistor is fitted properly. 			
Corrective action	<ul style="list-style-type: none"> • Check the option function setting, etc. • Connect the plug-in option securely. • Check the connection of communication cable. 			

Operation panel indication	E.16 to E.20	E. 16 to E. 20	FR-PU07	—
Name	User definition error by the PLC function			
Description	<p>The protective function is activated by setting "16 to 20" in the special register SD1214 for the PLC function. The inverter trips when the protective function is activated.</p> <p>The protective function is activated when the PLC function is enabled. This protective function is not available in the initial setting (Pr.414 = "0").</p> <p>Any character string can be displayed on FR-PU07 by sequence programs.</p>			
Check point	<ul style="list-style-type: none"> • Check if "16 to 20" is set in the special register SD1214. 			
Corrective action	<ul style="list-style-type: none"> • Set a value other than "16 to 20" in the special register SD1214. 			

Operation panel indication	E.PE	E. PE	FR-PU07	Corrupt Memory
Name	Parameter storage device fault (control circuit board)			
Description	The inverter trips if a fault occurs in the parameter stored. (EEPROM failure)			
Check point	Check for too many number of parameter write times.			
Corrective action	<p>Please contact your sales representative.</p> <p>Set "1" in Pr.342 Communication EEPROM write selection(write to RAM) for the operation which requires frequent parameter writing via communication, etc. Note that writing to RAM goes back to the initial status at power OFF.</p>			

Operation panel indication	E.PUE	E. PUE	FR-PU07	PU Leave Out
Name	PU disconnection			
Description	<ul style="list-style-type: none"> The inverter trips if communication between the inverter and PU is suspended, e.g. the operation panel or parameter unit is disconnected, when the disconnected PU disconnection function is valid in Pr.75 Reset selection/disconnected PU detection/PU stop selection. The inverter trips if communication errors occurred consecutively for more than permissible number of retries when Pr.121 Number of PU communication retries ≠ "9999" during the RS-485 communication. The inverter trips if communication is broken within the period of time set in Pr.122 PU communication check time interval during the RS-485 communication via the PU connector. 			
Check point	<ul style="list-style-type: none"> Check that the operation panel (FR-DU08) or the parameter unit (FR-PU07) is connected properly. Check the Pr.75 setting. 			
Corrective action	Fit the operation panel (FR-DU08) or the parameter unit (FR-PU07) securely.			

Operation panel indication	E.RET	E. RET	FR-PU07	Retry No Over
Name	Retry count excess			
Description	The inverter trips if the operation cannot be resumed properly within the number of retries set in Pr.67 Number of retries at fault occurrence .			
Check point	Find the cause of the fault occurrence.			
Corrective action	Eliminate the cause of the error preceding this error indication.			

Operation panel indication	E.PE2	E. PE2	FR-PU07	PR storage alarm
Name	Parameter storage device fault/Parameter storage device fault (main circuit board)			
Description	The inverter trips if a fault occurs in the parameter stored. (EEPROM failure)			
Check point				
Corrective action	Please contact your sales representative.			

Operation panel indication	CPU	E. CPU	FR-PU07	CPU Fault
	E. 5	E. 5		Fault 5
	E. 6	E. 6		Fault 6
	E. 7	E. 7		Fault 7
Name	CPU fault			
Description	The inverter trips if the communication fault of the built-in CPU occurs.			
Check point	Check for devices producing excess electrical noises around the inverter.			
Corrective action	<ul style="list-style-type: none"> Take measures against noises if there are devices producing excess electrical noises around the inverter. Please contact your sales representative. 			

Operation panel indication	E.CTE	E. CTE	FR-PU07	E.CTE
Name	Operation panel power supply short circuit RS-485 terminals power supply short circuit			
Description	<ul style="list-style-type: none"> When the power supply for the operation panel (PU connector) is shorted, the power output is shutoff and the inverter trips. The use of the operation panel (parameter unit) and the RS-485 communication via the PU connector are disabled. To reset, enter the RES signal from the terminal, reset via communication through the RS-485 terminals, or switch power OFF then ON again. When the power supply for the RS-485 terminals are short circuited, this function shuts off the power output. At this time, communication from the RS-485 terminals cannot be made. To reset, use  of the operation panel, enter the RES signal, or switch power OFF then ON again. 			
Check point	<ul style="list-style-type: none"> Check that the PU connector cable is not shorted. Check that the RS-485 terminals are connected correctly. 			
Corrective action	<ul style="list-style-type: none"> Check PU and the cable. Check the connection of the RS-485 terminals. 			

Causes and corrective actions

Operation panel indication	E.P24	E. P24	FR-PU07	E.P24
Name	24 VDC power fault			
Description	When the 24 VDC power output from the PC terminal is shorted, this function shuts off the power output. At this time, all external contact inputs switch OFF. The inverter cannot be reset by entering the RES signal. To reset it, use the operation panel, or switch power OFF, then ON again.			
Check point	<ul style="list-style-type: none"> • Check for a short circuit in the PC terminal output. • Check that the 24 V external power supply voltage is correct. 			
Corrective action	<ul style="list-style-type: none"> • Repair the short-circuited portion. • Supply the power at 24 V. (If the power at insufficient voltage is supplied to the 24V input circuit for a long time, the inverter internal circuit may heat up. Input power at correct voltage although it will not damage the inverter.) 			

Operation panel indication	E.CDO	E. CDO	FR-PU07	OC detect level
Name	Abnormal output current detection			
Description	The inverter trips if the output current exceeds the Pr.150 Output current detection level setting. This functions is available when Pr.167 Output current detection operation selection is set to "1". When the initial value (Pr.167 = "0") is set, this protective function is not available.			
Check point	Check the settings of Pr.150 , Pr.151 Output current detection signal delay time , Pr.166 Output current detection signal retention time , and Pr.167 . (Refer to page 381 .)			

Operation panel indication	E.IOH	E. IOH	FR-PU07	Inrush overheat
Name	Inrush current limit circuit fault			
Description	The inverter trips when the resistor of the inrush current limit circuit is overheated. The inrush current limit circuit failure			
Check point	<ul style="list-style-type: none"> • Check that frequent power ON/OFF is not repeated. • Check if the input side fuse (5A) in the power supply circuit of the inrush current limit circuit contactor (FR-A840-03250(110K) or higher) is blown. • Check that the power supply circuit of inrush current limit circuit contactor is not damaged. 			
Corrective action	Configure a circuit where frequent power ON/OFF is not repeated. If the situation does not improve after taking the above measure, please contact your sales representative.			

Operation panel indication	E.SER	E. SER	FR-PU07	VFD Comm error
Name	Communication fault (inverter)			
Description	The inverter trips when communication error occurs consecutively for the permissible number of retries or more when Pr.335 RS-485 communication retry count ≠ "9999" during RS-485 communication from the RS-485 terminals. The inverter also trips if communication is broken for the period of time set in Pr.336 RS-485 communication check time interval .			
Check point	Check the RS-485 terminal wiring.			
Corrective action	Perform wiring of the RS-485 terminals properly.			

Operation panel indication	E.AIE	E. AIE	FR-PU07	Analog in error
Name	Analog input fault			
Description	The inverter trips when a 30 mA or higher current or a 7.5 V or higher voltage is input to terminal 2 while the current input is selected by Pr.73 Analog input selection , or to terminal 4 while the current input is selected by Pr.267 Terminal 4 input selection .			
Check point	Check the Pr.73 , Pr.267 , and the voltage/current input switch settings.(Refer to page 391)			
Corrective action	Either give a current less than 30 mA, or set Pr.73 , Pr.267 , and the voltage/current input switch to the voltage input and input a voltage.			

Operation panel indication	E.USB	E. USB	FR-PU07	USB comm error
Name	USB communication fault			
Description	The inverter trips when the communication is cut off for the time set in Pr.548 USB communication check time interval .			
Check point	<ul style="list-style-type: none"> Check that the USB communication cable is connected securely. 			
Corrective action	<ul style="list-style-type: none"> Check the Pr.548 setting. Connect the USB communication cable securely. Increase the Pr.548 setting or set "9999." (Refer to page 574.) 			

Operation panel indication	E.SAF	E. SAF	FR-PU07	E.SAF Fault
Name	Safety circuit fault			
Description	<ul style="list-style-type: none"> The inverter trips when a safety circuit fault occurs. The inverter trips if the either of the wire between S1 and SIC or S2 and SIC becomes non-conductive while using the safety stop function. When not using the safety stop function, the inverter trips when the shorting wire between terminals S1 and PC or across S2 and PC is disconnected. 			
Check point	<ul style="list-style-type: none"> Check that the safety relay module or the connection has no fault when using the safety stop function. Check if the shorting wire between S1 and PC or between S2 and PC is disconnected when not using the safety stop function. 			
Corrective action	<ul style="list-style-type: none"> When using the safety stop function, check that wiring of terminal S1, S2 and SIC is correct and the safety stop input signal source such as a safety relay module is operating properly. Refer to the Safety stop function instruction manual for causes and countermeasures. (Please contact your sales representative for the manual.) When not using the safety stop function, short across terminals S1 and PC and across S2 and PC with shorting wires. (Refer to page 57.) 			

Operation panel indication	E.PBT	E. PBT	FR-PU07	Fault
	E.13	E. 13		Fault 13
Name	Opposite rotation deceleration fault			
Description	The inverter trips when an internal circuit fault occurs.			
Corrective action	Please contact your sales representative.			

Operation panel indication	E.OS	E. OS	FR-PU07	E.OS
Name	Overspeed occurrence			
Description	The inverter trips when the motor speed exceeds the Pr.374 Overspeed detection level under encoder feedback control, Real sensorless vector control, vector control, and PM sensorless vector control. This protective function is not available in the initial status.			
Check point	<ul style="list-style-type: none"> Check that the Pr.374 setting is correct. Check that the number of encoder pulses does not differ from the actual number of Pr 369 Number of encoder pulses (under encoder feedback control or vector control). 			
Corrective action	<ul style="list-style-type: none"> Set the Pr.374 correctly. Set the Pr 369 correctly (under encoder feedback control or vector control). 			

Causes and corrective actions

Operation panel indication	E.OSD 	E. 05d	FR-PU07	E.OSd
Name	Speed deviation excess detection			
Description	<ul style="list-style-type: none"> The inverter trips if the motor speed is increased or decreased under the influence of the load etc. during vector control with Pr.285 Speed deviation excess detection frequency set and cannot be controlled in accordance with the speed command value. While deceleration stop is attempted, if the motor is accelerated against the stop command accidentally by the incorrect setting of the number of encoder pulses, etc., the deceleration check function (Pr.690) is activated to stop the inverter output. 			
Check point	<ul style="list-style-type: none"> Check that the values of Pr.285 and Pr.853 Speed deviation time are correct. Check for sudden load change. Check that the number of encoder pulses does not differ from the actual number of Pr.369 Number of encoder pulses. 			
Corrective action	<ul style="list-style-type: none"> Set Pr.285 and Pr.853 correctly. Keep the load stable. Set Pr.369 correctly. 			

Operation panel indication	E.ECT	E. ECT	FR-PU07	E.ECT
Name	Signal loss detection			
Description	The inverter trips when the encoder signal is shut off under orientation control, encoder feedback control or vector control. This protective function is not available in the initial status.			
Check point	<ul style="list-style-type: none"> Check for the encoder signal loss. Check that the encoder specifications are correct. Check for a loose connector. Check that the switch setting of FR-A8AP (option) is correct. Check that the power is supplied to the encoder. Alternatively, check that the power is not supplied to the encoder later than the inverter. Check that the voltage of the power supplied to the encoder is the same as the encoder output voltage. 			
Corrective action	<ul style="list-style-type: none"> Remedy the signal loss. Use an encoder that meets the specifications. Make connection securely. Make a switch setting of FR-A8AP (option) correctly. (Refer to page 63.) Supply the power to the encoder. Or supply the power to the encoder at the same time when the power is supplied to the inverter. <p>If the power is supplied to the encoder after sent to the inverter, check that the encoder signal is properly sent and set "0 (initial value)" in Pr.376 Encoder signal loss detection enable/disable selection to disable signal loss detection.</p> <ul style="list-style-type: none"> Make the voltage of the power supplied to the encoder the same as the encoder output voltage. 			

Operation panel indication	E.OD 	E. Od	FR-PU07	E.Od
Name	Excessive position fault			
Description	The inverter trips when the difference between the position command and position feedback exceeds Pr.427 Excessive level error under position control.			
Check point	<ul style="list-style-type: none"> Check that the position detecting encoder mounting orientation matches the parameter. Check that the load is not large. Check that the Pr.427, Pr.369 Number of encoder pulses settings are correct. 			
Corrective action	<ul style="list-style-type: none"> Check the parameters. Reduce the load. Set Pr.427, Pr.369 correctly. 			

Operation panel indication	E.MB1 to 7	E. Mb 1 to E. Mb 7	FR-PU07	E.MB1 Fault to E.MB7 Fault
Name	Brake sequence fault			
Description	<ul style="list-style-type: none"> The inverter trips when a sequence error occurs during use of the brake sequence function (Pr.278 to Pr.285). This protective function is not available in the initial status. (The brake sequence function is invalid.) (For the details of fault record, refer to page 457.) 			
Check point	Find the cause of the fault occurrence.			
Corrective action	Check the set parameters and perform wiring properly.			

Operation panel indication	E.EP 	E. EP	FR-PU07	E.EP
Name	Encoder phase fault			
Description	The inverter trips when the rotation command of the inverter differs from the actual motor rotation direction detected from the encoder during offline auto tuning. This protective function is not available in the initial status.			
Check point	<ul style="list-style-type: none"> Check for mis-wiring of the encoder cable. Check if the Pr.359 Encoder rotation direction setting is incorrect. 			
Corrective action	<ul style="list-style-type: none"> Perform connection and wiring securely. Change the Pr.359 setting. 			

Operation panel indication	E.IAH	E. IAH	FR-PU07	Fault
Name	Abnormal internal temperature (IP55 compatible models only)			
Description	The inverter trips when the inverter internal temperature reaches the specified value or higher.			
Check point	<ul style="list-style-type: none"> Check for too high surrounding air temperature. Check if the internal air circulation fan or the cooling fan stops due to a fault. 			
Corrective action	<ul style="list-style-type: none"> Install an inverter suitable for the installation environment. (Refer to the Instruction Manual (Hardware) of the FR-A806.) Replace the internal air circulation fan or the cooling fan. 			

Operation panel indication	E.LCI	E. LCI	FR-PU07	Fault
Name	4 mA input fault			
Description	The inverter trips when the analog input current is 2 mA or less for the time set in Pr.778 Current input check filter . This function is available when Pr.573 4 mA input check selection = "2 or 3". (Refer to page 412 .) This function is not available in the initial status.			
Check point	<ul style="list-style-type: none"> Check for a break in the wiring for the analog current input. Check that the Pr.778 setting is not too short. 			
Corrective action	<ul style="list-style-type: none"> Check the wiring for the analog current input. Set the Pr.778 setting larger. 			

Operation panel indication	E.PCH	E. PCH	FR-PU07	Fault
Name	Pre-charge fault			
Description	<ul style="list-style-type: none"> The inverter trips when the pre-charge time exceeds Pr.764 Pre-charge time limit. The inverter trips when the measured value exceeds Pr.763 Pre-charge upper detection level during pre-charging. This function is available when Pr.764 and Pr.763 are set. This protective function is not available in the initial status. 			
Check point	<ul style="list-style-type: none"> Check that the Pr.764 setting is not too short. Check that the Pr.763 setting is not too small. Check that the Pr.127 PID control automatic switchover frequency setting is not too low. Check for a break in the connection to the pump. 			
Corrective action	<ul style="list-style-type: none"> Set the Pr.764 setting longer. Set the Pr.763 setting larger. Set the Pr.127 setting higher. Check the connection to the pump. 			

Causes and corrective actions

Operation panel indication	E.PID	E. P I d	FR-PU07	Fault PID Signal Error
Name	PID signal fault			
Description	The inverter trips if the measured value exceeds the PID upper limit or PID lower limit parameter setting, or the absolute deviation value exceeds the PID deviation parameter setting during PID control. Set this function in Pr.131 PID upper limit , Pr.132 PID lower limit , Pr.553 PID deviation limit , and Pr.554 PID signal operation selection . (Refer to page 483 .) This protective function is not available in the initial status.			
Check point	<ul style="list-style-type: none"> Check the meter for a failure or break. Check that the parameter settings are correct. 			
Corrective action	<ul style="list-style-type: none"> Check that the meter has no failure or break. Set the parameters correctly. 			

Operation panel indication	E. 1 to E. 3	E. 1 to E. 3	FR-PU07	Fault 1 to Fault 3
Name	Option fault			
Description	The inverter trips when a contact fault is found between the inverter and the plug-in option, or when the communication option is not connected to the connector 1. Appears when the switch for manufacturer setting of the plug-in option is changed.			
Check point	<ul style="list-style-type: none"> Check that the plug-in option is plugged into the connector properly. (1 to 3 indicate connector numbers for connection of options.) Check for excessive noise around the inverter. Check if the communication option is connected to the connector 2 or 3. 			
Corrective action	<ul style="list-style-type: none"> Connect the plug-in option securely. Take measures against noises if there are devices producing excess electrical noises around the inverter. If the situation does not improve after taking the above measure, please contact your sales representative. Connect the communication option to the connector 1. Set the switch on the plug-in option, which is for manufacturer setting, back to the initial setting. (Refer to the Instruction Manual of each option.) 			

Operation panel indication	E.11 Sensorless	E. 11	FR-PU07	Fault 11
Name	Opposite rotation deceleration fault			
Description	The speed may not decelerate during low speed operation if the rotation direction of the speed command and the estimated speed differ when the rotation is changing from forward to reverse or from reverse to forward during torque control under Real sensorless vector control. The inverter trips when overload occurs due to the un-switched rotation direction. This protective function is not available in the initial status (V/F control). (This function is only available under Real sensorless vector control.)			
Check point	<ul style="list-style-type: none"> Check that the rotation direction is not switched from forward to reverse rotation (or from reverse to forward) during torque control under Real sensorless vector control. 			
Corrective action	<ul style="list-style-type: none"> Prevent the motor from switching the rotation direction from forward to reverse (or from reverse to forward) during torque control under Real sensorless vector control. Please contact your sales representative. 			

CAUTION

- If protective functions with indication of "Fault" are activated when using the FR-PU07, "ERR" appears in the faults history of FR-PU07.
- If faults other than the above appear, contact your sales representative.